

Proportional rotary solenoid

6

Product group

G DR

Function Proportional Rotary Solenoid

- Linear torque vs. rotation angle characteristic
- Constant torque in the operating range
- Proportional behaviour between torque and current
- Short correcting times through pre-magnetized system
- Clockwise and anti-clockwise by reversing the polarity

Construction Proportional Rotary Solenoid

- Armature guided in ball bearings
- Fastening via thread bores at the end faces
- Insulation materials of the exciter coil correspond to thermal class B
- Electrical connection via free flexible lead ends
- Protection class according to DIN VDE / EN 60529 when it is properly installed: IP 20

Function and construction rotation angle position sensor

- Measuring principle: Hall sensor
- Stable aluminium sensor housing
- Flange mounted directly to the rotary solenoid
- Electrical connection via free flexible lead ends
- Protection class according to DIN VDE / EN 60529 when it is properly installed: IP 20

Application examples

- Drive for industrial actuators, measuring and control technology
- Rotary slide and flap valves in fluid technology
- The type with rotation angle-position-sensor can be operated in the closed rotation angle loop

Options and accessories

- Flange option of a return spring
- Execution with programmable hall sensor on request
- Please contact us for application related solutions

Standards

- Design and testing according to VDE 0580
- Production according to ISO 9001



Fig. 1: Type G DR X 050 X20 A01
Without rotation position sensor



Fig. 2: Type G DR X 050 X20 A61
With rotation position sensor

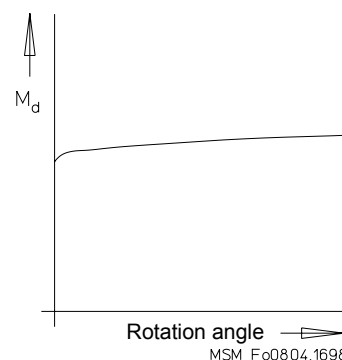

Fig. 3: Torque characteristic

Technical data proportional rotary solenoids of the series G DR

G DR X	035					050					075				
Rated voltage U_N (V)	= 24														
Operating mode ED	S1 100 %	S3 40 %	S3 25 %	S3 15 %	S3 5 %	S1 100 %	S3 40 %	S3 25 %	S3 15 %	S3 5 %	S1 100 %	S3 40 %	S3 25 %	S3 15 %	S3 5 %
Rated power P_{20} (W)	6,6	15,6	24,6	37	80	11	21	40	65	144	25	50	82	146	331
Torque M_d (Ncm)	2,1	3,3	4,1	5,1	7,2	6	8,6	11,6	16	23	24	35	48	61	85
Reference temperature ϑ_{11} (°C)	35					35					35				
Rotation angle (°)	110					110					110				
Mass m (kg)	0,156					0,425					1,42				
Moment of inertia of the armature J (kgm ²)	$1,9 \times 10^{-6}$					$1,1 \times 10^{-5}$					$1,1 \times 10^{-4}$				

Technical data	G DR X 035 X 20 A 61 G DR X 050 X 20 A 61 G DR X 075 X 20 A 61	
Rotation angle position sensor on proportional rotary solenoids		
Measuring range (°)	±55	
Supply voltage (V)	4,5 ... 6	
Current consumption (mA)	<14	
Output voltage (V)	1,8 ... 3,1	e.g. at $U_{Supply} = 5 V$
In central position (V)	2,5±0,25	
Sensitivity (mV/1°)	typically 11±1	
Linearity tolerance (%)	±3	
Limit frequency (-3 dB) (kHz)	typically 23	
Reference temperature range (°C)	0 ... 50	
Temperature drift (%/°C)	typically 0,05	
Output resistance (Ω)	50	
Sensitivity	The sensitivity is the change output signal referring to the measurement path (indicated in mV/1°).	
Linearity fault	Linearity fault indicates the deviation (in per cent) of the output signal from the ideal straight line	
Temperature drift	Temperature drift indicates the deviation (in per cent) of the output signal per degree of the temperature change (indicated in %/°C).	
Limit frequency	In reference to the Hall sensor	

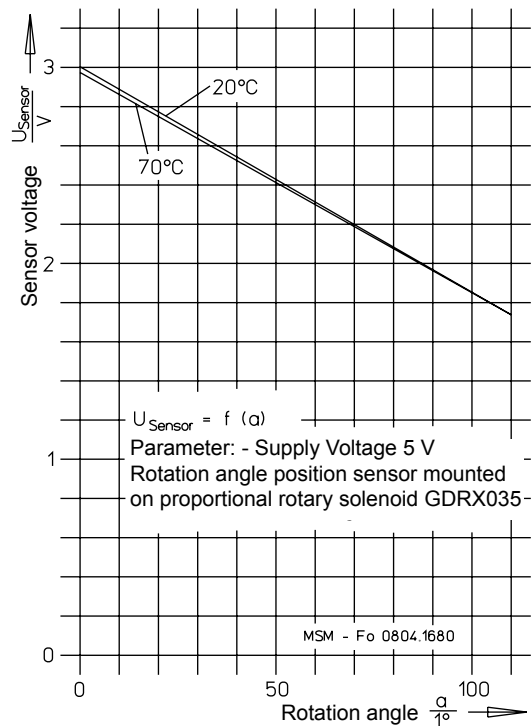

Fig. 4: Voltage vs. rotation angle characteristic of rotation angle position sensor

Notes on the tables

The torques indicated in the tables refer to 90% of the rated voltage = 24 V and normal operating temperature. For other rated voltages deviations of the torque may occur. The torque values may deviate by approx. ±10% due to natural dispersion.

The normal operating temperature is based on

- Mounting on heat-insulating base
- Rated voltage = 24 V
- Operating mode S3 5% - S1 according to part list G XX section 4
- Reference temperature 35°C

Rated voltage

Rated voltage = 24V, other voltages on request.

The devices correspond to protection class III. Electrical equipment of protection class III may be only connected to low voltage systems (PELV, SELV)(IEC 60364-4-41).

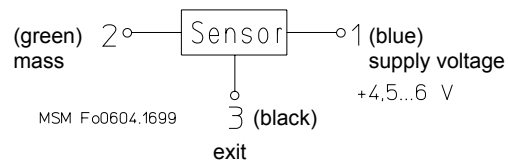

Fig 5: Block diagram

Type G DR X 035

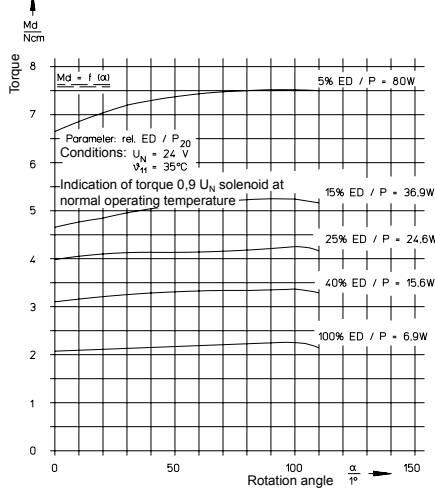

Fig. 6: Characteristics $M_d = f(d)$ MSM-Fo 0804.1692
Type G DR X 035

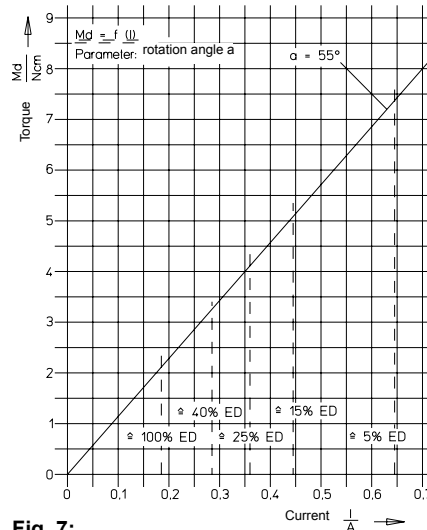

Fig. 7: Characteristics $M_d = f(I)$ MSM-Fo 0804.1695
Type G DR X 035

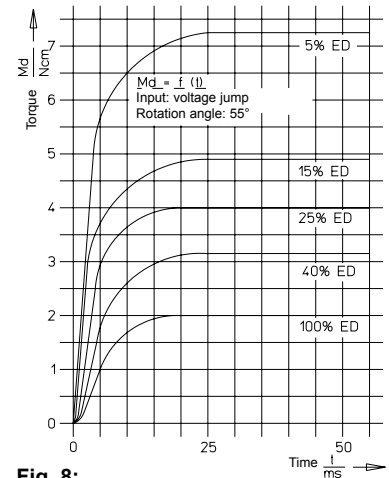

Fig. 8: Characteristics $M_d = f(t)$ MSM-Fo 0804.1675
Type G DR X 035

Type G DR X 050

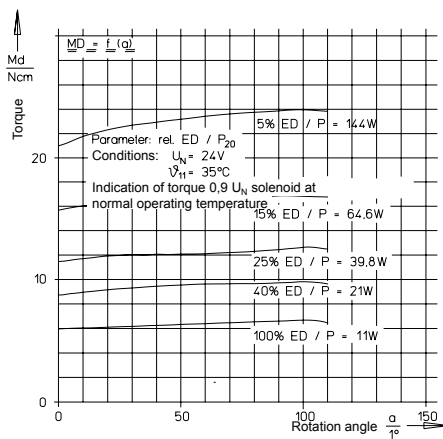

Fig. 9: Characteristics $M_d = f(d)$ MSM-Fo 0804.1693
Type G DR X 050

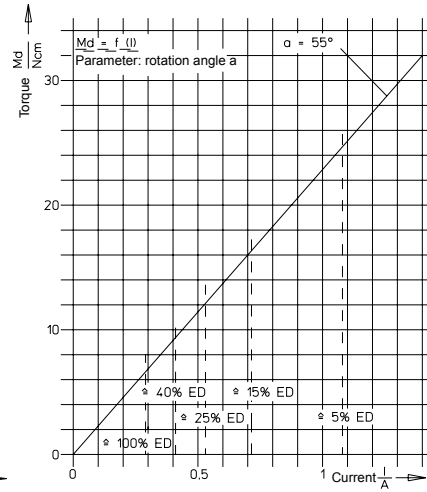

Fig. 10: Characteristics $M_d = f(I)$ MSM-Fo 0804.1696
Type G DR X 050

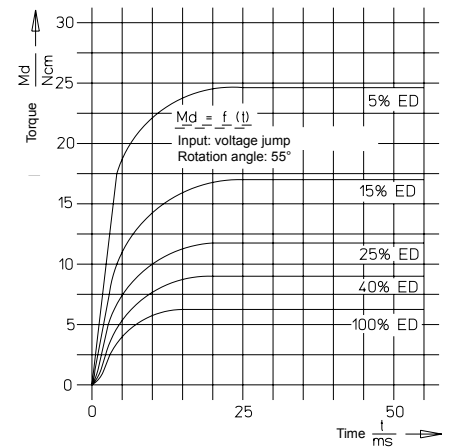

Fig. 11: Characteristics $M_d = f(t)$ MSM-Fo 0804.1676
Type G DR X 050

Type G DR X 075

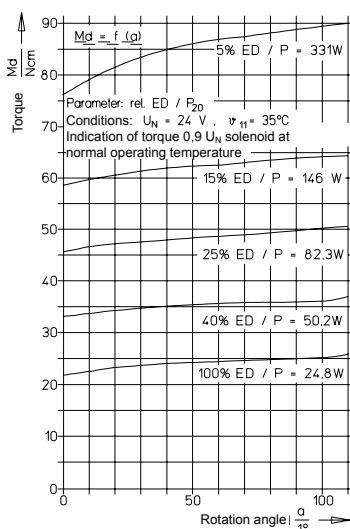

Fig. 12: Characteristics $M_d = f(d)$ MSM-Fo 0804.1694
Type G DR X 075

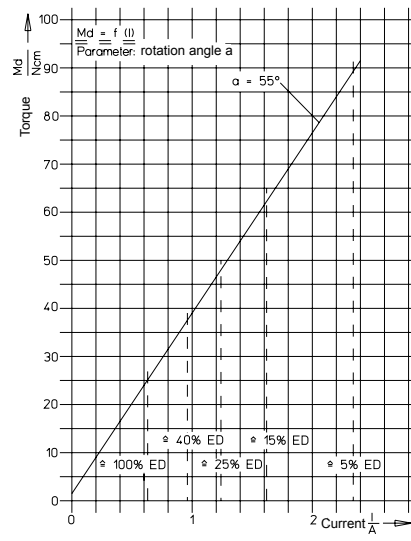

Fig. 13: Characteristics $M_d = f(I)$ MSM-Fo 0804.1697
Type G DR X 075

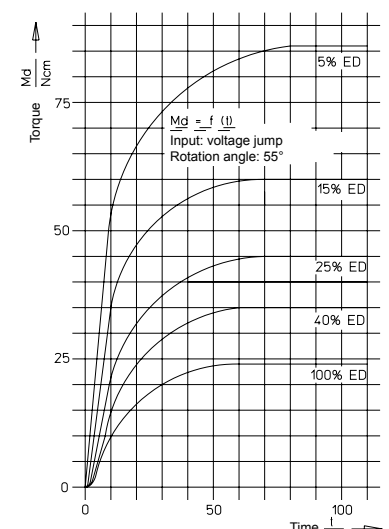
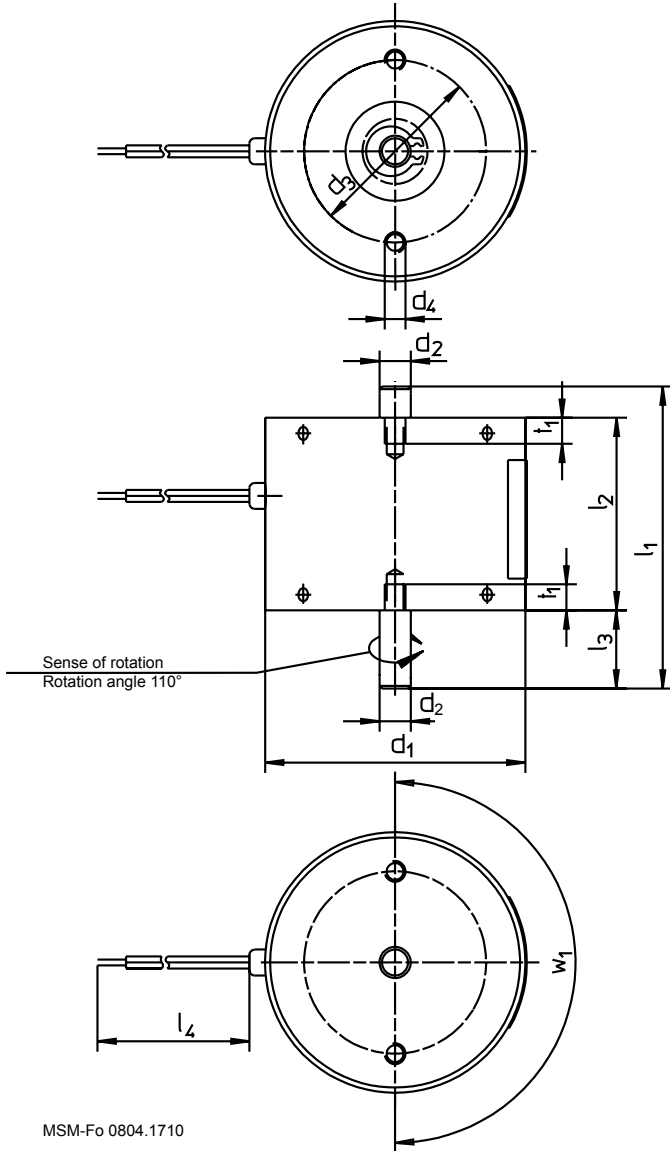

Fig. 14: Characteristics $M_d = f(t)$ MSM-Fo 0804.1677
Type G DR X 075



MSM-Fo 0804.1710

Fig. 15:
Dimensions
Type G DR X 035 X 20 A01
to type G DR X 075 X 20 A01

G DR ... A01			
Size	035	050	075
Dim.	Dimensions in mm		
d_1	35	50	75
d_2	4_{h8}	6_{h8}	10_{h8}
d_3	25	35	50
d_4	M3	M4	M5
d_5	35	35	35
l_1	46	58	86
l_2	30	37	56
l_3	10	15	20
l_4	100	150	200
$^1)t_1$	3,5	5	8
w_1	$2 \times 180^\circ$	$2 \times 180^\circ$	$2 \times 180^\circ$

¹⁾ We ask you to please do not exceed the screw depth t_1 , because this could lead to damage of the coil.

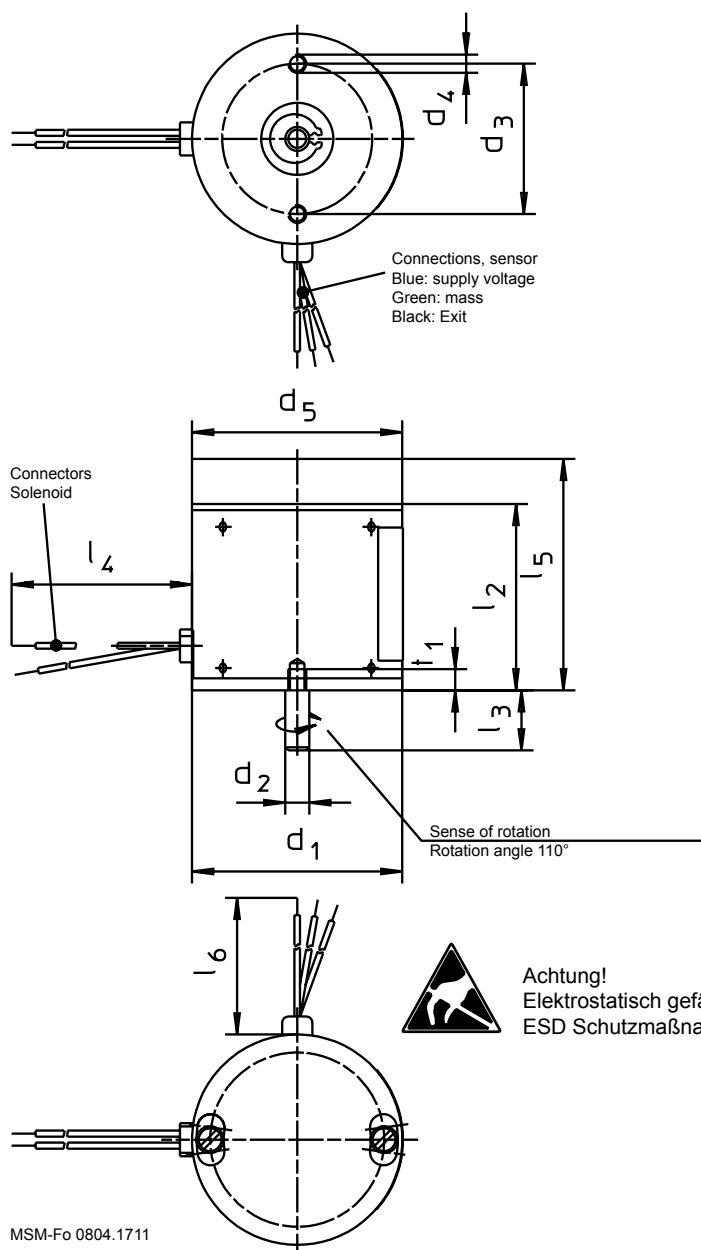

Fig. 16:
Dimensions
Type G DR X 035 X 20 A61
to type G DR X 075 X 20 A61
With rotation angle position sensor

Information and remarks concerning European directives
can be taken from the correspondent information sheet which is available under Produktinfo.Magnet-Schultz.com.

Note on the RoHS Directive

The devices presented in this document do not fall into the scope of RoHS Directive and to our knowledge they do not become part of products which fall into this scope. In case of surfaces zinc coating with yellow chromating and zinc iron with black chromating separate agreements are necessary for applications within the scope of RoHS.

G DR ... A61			
Size	035	050	075
Dim.	Dimensions in mm		
d ₁	35	50	75
d ₂	4 _{h8}	6 _{h8}	10 _{h8}
d ₃	25	35	50
d ₄	M3	M4	M5
d ₅	35	35	35
l ₂	30	37	56
l ₃	10	15	20
l ₄	100	150	200
l ₅	38,5	45,5	64,5
l ₆	200	200	200
¹⁾ t ₁	3,5	5	8

¹⁾ We ask you to please do not exceed the screw depth t₁, because this could lead to damage of the coil.

Missing dimensions see fig. 15

Please make sure that the described devices are suitable for your application. Supplementary information concerning its proper installation can be taken also from the -Technical Explanation, the effective DIN VDE0580 as well as the relevant specifications.

This part list is a document for technically qualified personnel. The present publication is for informational purposes only and shall not be construed as mandatory illustration of the products unless otherwise confirmed expressly.

Installation instructions

The rotary solenoids may be inserted in any mounting position. In the interest of the service life and function of the bearing, please make sure that impacts and bigger pressures on the rotation axis in axial direction are avoided.

It is advisable to do not intercept bigger, with the axis connected masses with the stops inside the solenoid but by external stops or damping elements installed by the customer.

The device may not show any mechanical or electrical damages.

For applications with dynamic loads we recommend to perform switching life time tests.

Type code

Benennung	Ausführung	Baugröße (ø)	Standardwerte Spannung, Einschaltdauer
G DR X 035 X20 A01		37 mm	24VDC, 100% ED, 40% ED, 25% ED, 15% ED, 5% ED
G DR X 050 X20 A01		45 mm	
G DR X 075 X20 A01		63 mm	
G DR X 035 X20 A61	mit Drehwinkelsensor	37 mm	
G DR X 050 X20 A61		45 mm	
G DR X 075 X20 A61		63 mm	

Order example

Type G DR X 035 X20 A01
Voltage == 24 V DC
Operating mode S1 (100 %)

Specials designs

Please do not hesitate to ask us for application-oriented problem solutions. In order to find rapidly a reliable solution we need complete details about your application conditions. The details should be specified as precisely as possible in accordance with the relevant  -Technical Explanations.

If necessary, please request the support of our corresponding technical office.